



INSTALLATION AND OPERATION MANUAL

Jandy Pro Series Levolor® II Electronic Water Leveler Model K-2000



WARNING

FOR YOUR SAFETY - This product must be installed and serviced by a contractor who is licensed and qualified in pool equipment by the jurisdiction in which the product will be installed where such state or local requirements exist. The maintainer must be a professional with sufficient experience in pool equipment installation and maintenance so that all of the instructions in this manual can be followed exactly. Before installing this product, read and follow all warning notices and instructions that accompany this product. Failure to follow warning notices and instructions may result in property damage, personal injury, or death. Improper installation and/or operation will void the warranty. Improper installation and/or operation can create unwanted electrical hazard which can cause serious injury, property damage, or death.



ATTENTION INSTALLER - This manual contains important information about the installation, operation and safe use of this product. This information should be given to the owner/operator of this equipment.

Table of Contents

Section 1. Safety Information	4
Section 2. System Description	5
2.1 Electrical Specifications	5
2.2 Schematic	6
Section 3. Installation Instructions	7
3.1 Materials and Tools	7
3.2 Installing the Control Box.....	7
3.3 Changing Wiring for 110 Volt Operation	8
3.4 Grounding	8
3.5 Installing the Valve and Relay.....	9
3.6 Installing the Sensor	11
3.7 Vanishing Edge Pool Installation	12
Section 4. Operation.....	13
4.1 Controller Lights.....	13
4.2 Fill Safety Lockout Mode	14
4.3 Pump On Delay Variable Timer	14
4.4 Pump Off Delay Variable Timer	15
4.5 Change Jumpers and Dip Switches	15
Section 5. Troubleshooting	16
5.1 Observations at Job Site.....	16
5.2 Test Operation of Control Unit	16
5.3 Fill Valve Will Not Turn OFF.....	18
5.4 Fill Valve Will Not Turn ON	19

Section 1. Safety Information

IMPORTANT SAFETY INSTRUCTIONS PERTAINING TO A RISK OF PROPERTY DAMAGE OR INJURY TO PERSONS READ AND FOLLOW ALL INSTRUCTIONS

When installing and using this equipment, basic safety precautions should always be observed, including the following:

WARNING

FOR YOUR SAFETY. This product must be installed and serviced by a professional service technician, qualified in pool/spa installation and maintenance. Improper installation or operation could cause serious injury, property damage, or death. Improper installation or operation will void the warranty.

WARNING

Before installing this product, read and follow all warning notices and instructions accompanying it. Failure to follow safety warnings and instructions could result in severe injury, death, or property damage.

WARNING

To reduce the risk of injury, do not permit children to use this product unless they are closely supervised at all times.

WARNING

Risk of electric shock - Install the control box at least five (5) feet (152.4cm) from the inside wall of the pool and/or hot tub using non-metallic plumbing. Canadian installations must be at least three (3) meters from the water. Children should not use spas or hot tubs without adult supervision. Do not use spas or hot tubs unless all suction guards are installed to prevent body and hair entrapment. People using medications and/or having an adverse medical history should consult a physician before using a spa or hot tub.

CAUTION

Sensor wires must be continuous and not spliced. Solder all low voltage wire connections when possible and always use grease-filled wire nuts on low voltage connections.



ATTENTION INSTALLER: Install to provide drainage of compartment for electrical components.



ATTENTION INSTALLER: This manual contains important information about the installation, operation and safe use of this product. This information should be given to the owner/operator of this equipment.

SAVE THESE INSTRUCTIONS

Section 2. System Description

Levolor II by Jandy Model K-2000 is a computer-controlled device that detects low and high water conditions.

This model can be used in any situation where a consistent liquid level is desired and a high and low level situation can be detected and acted upon, such as a Vanishing Edge pool. It automatically fills the pool when the water level is too low and stops filling the pool when the water level is normal

The K-2000 Kit contains a sensor, remote sensor housing, control box, and solenoid valve. For details about the materials in the kit and a list of additional materials needed to install the K-2000 kit, refer to *Section 3.1, Materials and Tools*.

Sensor

The sensor has three (3) probes: one (1) short probe to measure the high water level, one (1) long probe to measure the minimum operating level of the water, and one (1) long common probe. The long probes come in 4", 18" and 30" lengths.

The sensor is a slip-type sensor that glues to a 1" coupling.

Depending on the kit, the sensor comes with 50 to 500 feet of wire at the top and three (3) stainless steel contacts at the bottom. The excess wire should be cut off after you have completed the installation.

Control Box

The control box has five (5) LED lights. They are:

- Power
- Sensor
- Fill
- High Water Sensor
- High Water Pump

For details about the functions of the lights, refer to *Section 4.1, Controller Lights*.

The control box is factory wired for 220 volt operation, but can optionally be rewired for 110 volt operation. See *Section 3.3, Changing Wiring for 110 Volt Operation*.

Valve

The K-2000 requires one (1) 24VAC solenoid valve. The Jandy-supplied valve (PN SOL100) has a pressure rating that cannot exceed 125 PSI.

2.1 Electrical Specifications

Input: 110VAC, 50/60 HZ, 0.5 AMPS
220VAC, 50/60 HZ, 0.5 AMPS

Valve Output: 24VAC@ 1 AMP

Relay Output: 24VDC@ 1 AMP

CAUTION

Model K-2000 is factory wired for 220VAC service. If available electrical service is 110VAC, the power supply wiring must be changed to operate on 110VAC as shown in Figures 3 and 4.

2.2 Schematic

This section contains a schematic for the K-2000.

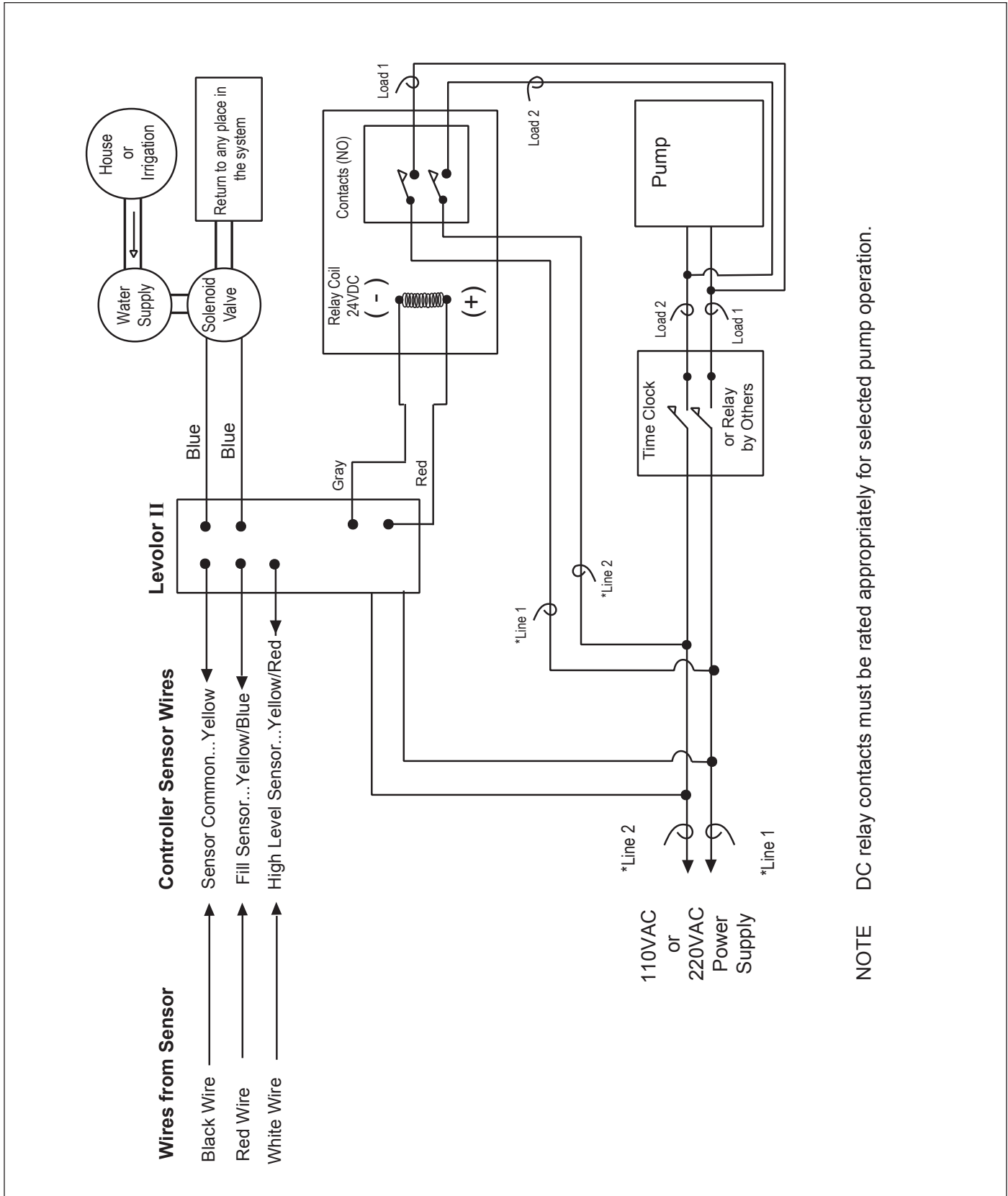

Figure 1. K-2000 Schematic

Section 3. Installation Instructions

3.1 Materials and Tools

Installation Materials Furnished for Levolor II, Model K-2000	Qty
Three-probe Sensor with Wire	1
24VAC Solenoid Valve	1
1" Coupler	1
Control Box (K-2000)	1
Remote Sensor Housing	1
Hardware Kit	1
Grease-Filled Wire Nuts for Valve	2 per kit
Screws	4 per kit
Anchors	4 per kit
Installation and Operation Manual - Warranty Information	1

Additional Materials Needed for Installation
DPST (Dual Pole Single Throw) 24VDC Relay with Contacts Properly Rated for Pump Selected
Anti-Siphon Valve*
2-Conductor 18-Gauge Solid-Core Burial Cable
Wire Nut Connectors for the Sensor, Relay, and Power Connections.

*The anti-siphon valve is not necessary if the connection is made from the irrigation system.

NOTE You can order a 24VDC relay rated for 3 HP from Jandy (Part No. R0658100).

Open the box and check to see that it contains the contents listed above. If it does not, contact your dealer or Zodiac technical support at 1 (800)-822-7933.

3.2 Installing the Control Box

1. Mount the control box to the wall near the pump and filter. See Figure 2. Do not install the control box within 10 feet (3 meters) of the pool edges.

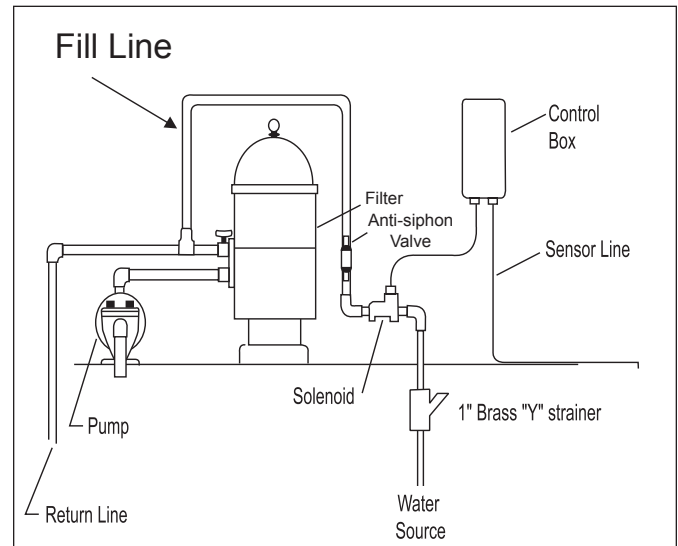

Figure 2. K-2000 Installation

2. Mount the control box at eye level. Leave sufficient clearance on all sides of the chassis backplate.
3. Check the source voltage. (The unit is factory wired for 220 volt operation.) To modify the wiring for 110 volt operation, see *Section 3.3, Changing Wiring for 110 Volt Operation*.
4. For 220 volt operation, connect the black wire to line 1 and connect the black wire with the yellow stripe to line 2. See Figure 3.

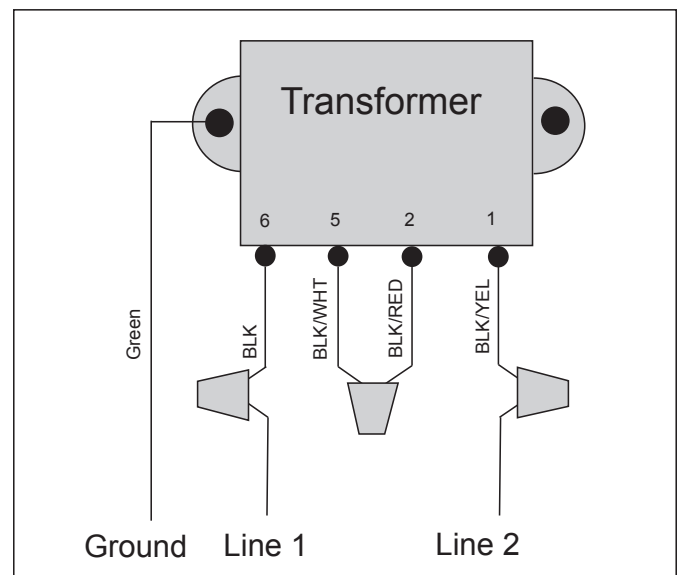

Figure 3. Factory Wiring for 220 Volt Operation

3.3 Changing Wiring for 110 Volt Operation

⚠ WARNING

Potentially high voltages in the Levolor control box can create dangerous electrical hazards, possibly causing death, serious injury or property damage. Turn off power at the main circuit breaker providing power to the control box to disconnect the control box from the system. To properly and safely wire the system, be sure to carefully follow the applicable requirements of the National Electrical Code (NEC), NFPA 70 or the Canadian Electrical Code (CEC), CSA C22.1. All applicable local installation codes must also be adhered to.

Refer to Figures 3 and 4 and do the following:

1. Cut the splice cap connecting the black/white and the black/red wires. See Figure 3.
2. Connect the black/red wire with the black wire and connect to the line side of power. See Figure 4.
3. Connect the black/white wire with the black/yellow wire and connect to the neutral side of power. See Figure 4.

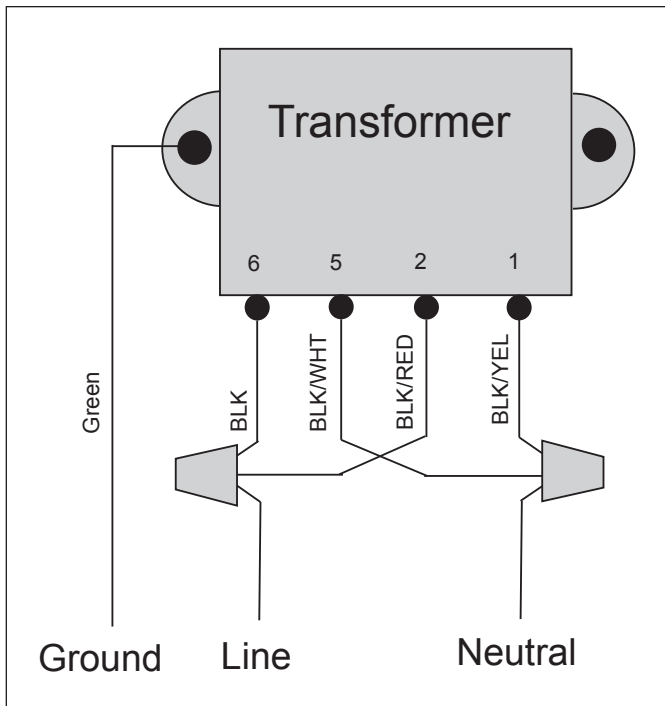

Figure 4. Modified Wiring for 110 Volt Operation

3.4 Grounding

Connect the green ground wire marked \oplus to the grounding terminal of your electrical service or supply panel with a continuous copper conductor having green insulation. It must be equivalent in size to the circuit conductors supplying this equipment, but no smaller than No. 12 AWG (3.3mm). Refer to your local codes for the acceptable grounding wire gauge.

3.5 Installing the Valve and Relay

NOTE Install the valve with the directional water flow arrow pointing in the appropriate direction. The directional water flow arrow is located on the inlet side of the valve.

A 24VAC solenoid valve will provide water from a supply line to the pool. You can install the supply line either before or after the filter at the equipment pad or on a dedicated line back to the pool.

Zodiac recommends a minimum $\frac{3}{4}$ " valve and an anti-siphon valve, which provides inexpensive insurance against accidental draining of the pool.

Always use an in-line strainer, which can be purchased from Zodiac.

1. Connect the 24VAC water solenoid valve to the 18-gauge solid-core burial cable using the supplied grease-filled wire nuts.
2. Connect the wires from the Fill Valve to the blue wires in the control box using wire nuts. See Figure 7, Control Box Wiring, on page 10.
3. Connect the wires from the High Level DC Relay to the gray wire (-) and the red wire (+) in the control box using wire nuts. See Figure 7, Control Box Wiring, on page 10.
4. Turn the flow control knob (+) on the top of the valve (See Figure 5) to set the flow rate to your specifications. (The rate can be set up to 30 GPM.)
5. Put the manual ON/OFF lever, located just below the solenoid, in the OFF position, so it can only be opened with the electronic water Levolor. See Figure 6.

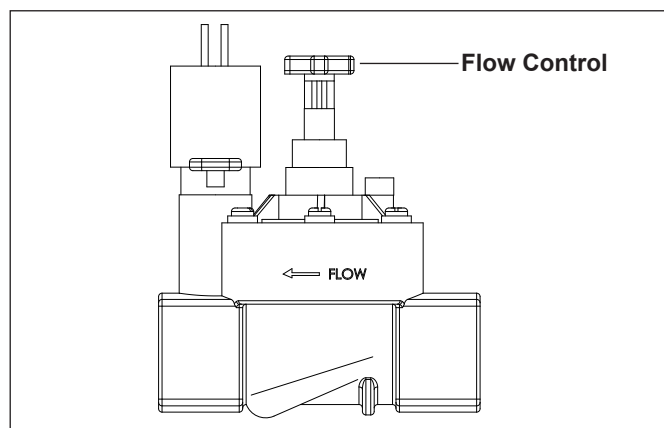

Figure 5. Valve Flow Controller

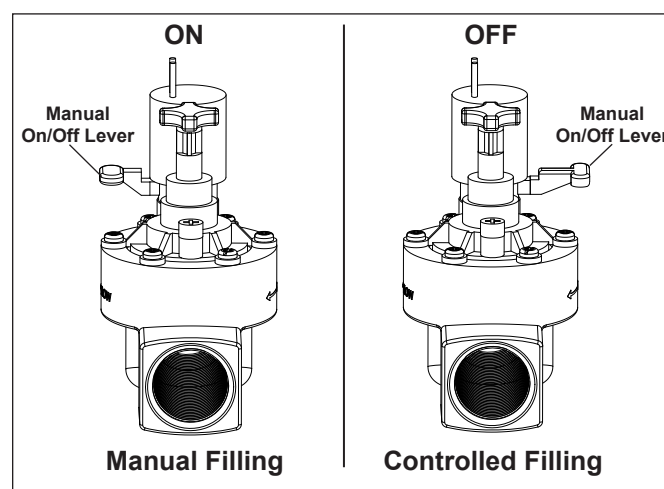

Figure 6. Manual Valve Lever

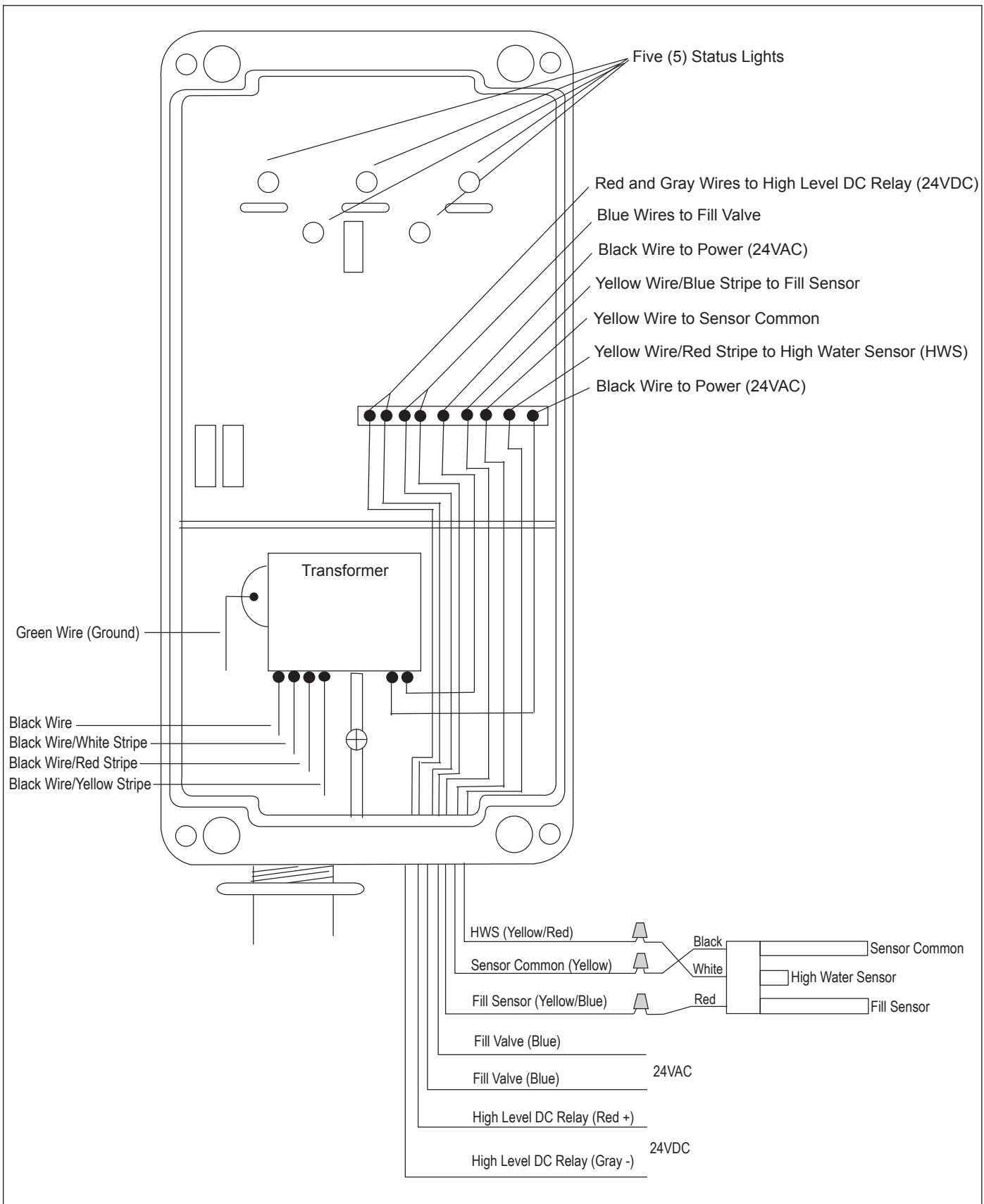

Figure 7. Control Box Wiring

3.6 Installing the Sensor

1. Mount the slip sensor vertically in a static pipe.
See Figure 8.

NOTE Glue 1" fittings with 793 IPS brand ABS/PVC glue. Do not glue 2" fittings.

NOTE Sensor wires must be continuous and not spliced. Solder all low voltage wire connections when possible and always use grease-filled wire nuts on low voltage connections.

2. Connect the sensor wires as follows. Refer to Figure 7, Control Box Wiring, page 10 and Table 1, Sensor Wire Connections, shown below.
 - a. Connect the black wire from the Sensor Common probe to the yellow wire in the control box using a wire nut.
 - b. Connect the red wire from the Fill Sensor probe to the yellow wire with the blue stripe in the control box using a wire nut.
 - c. Connect the white wire from the High Water Sensor probe to the yellow wire with the red stripe in the control box using a wire nut.

Table 1. Sensor Wire Connections

Sensor Wires	Control Box Wires
Black (Sensor Common Probe)	Yellow
Red (Fill Sensor Probe)	Yellow/Blue Stripe
White (High Water Sensor Probe)	Yellow/Red Stripe

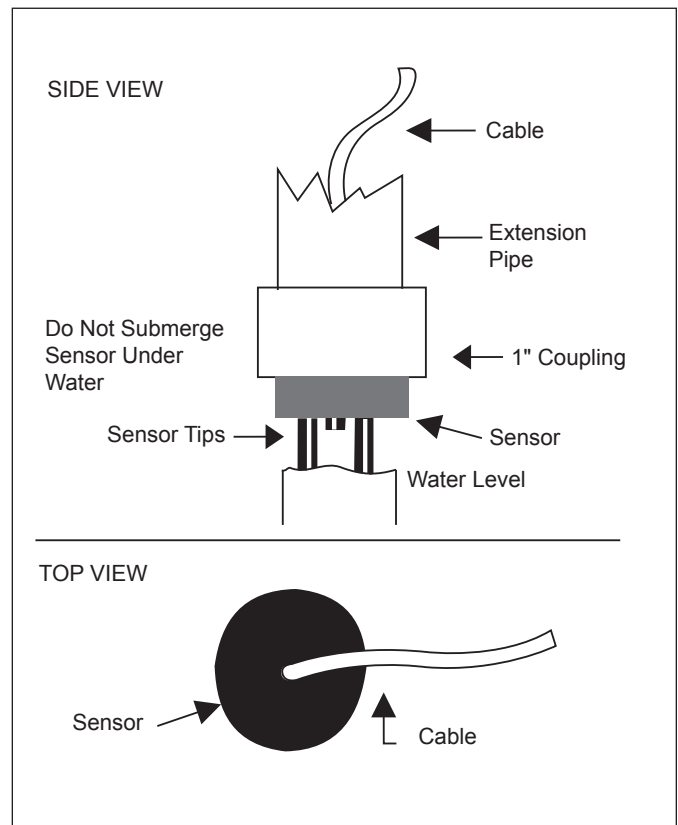

Figure 8. Slip Sensor on Static Pipe

3.7 Vanishing Edge Pool Installation

Figure 9 shows the installation of a pool with a vanishing edge design.

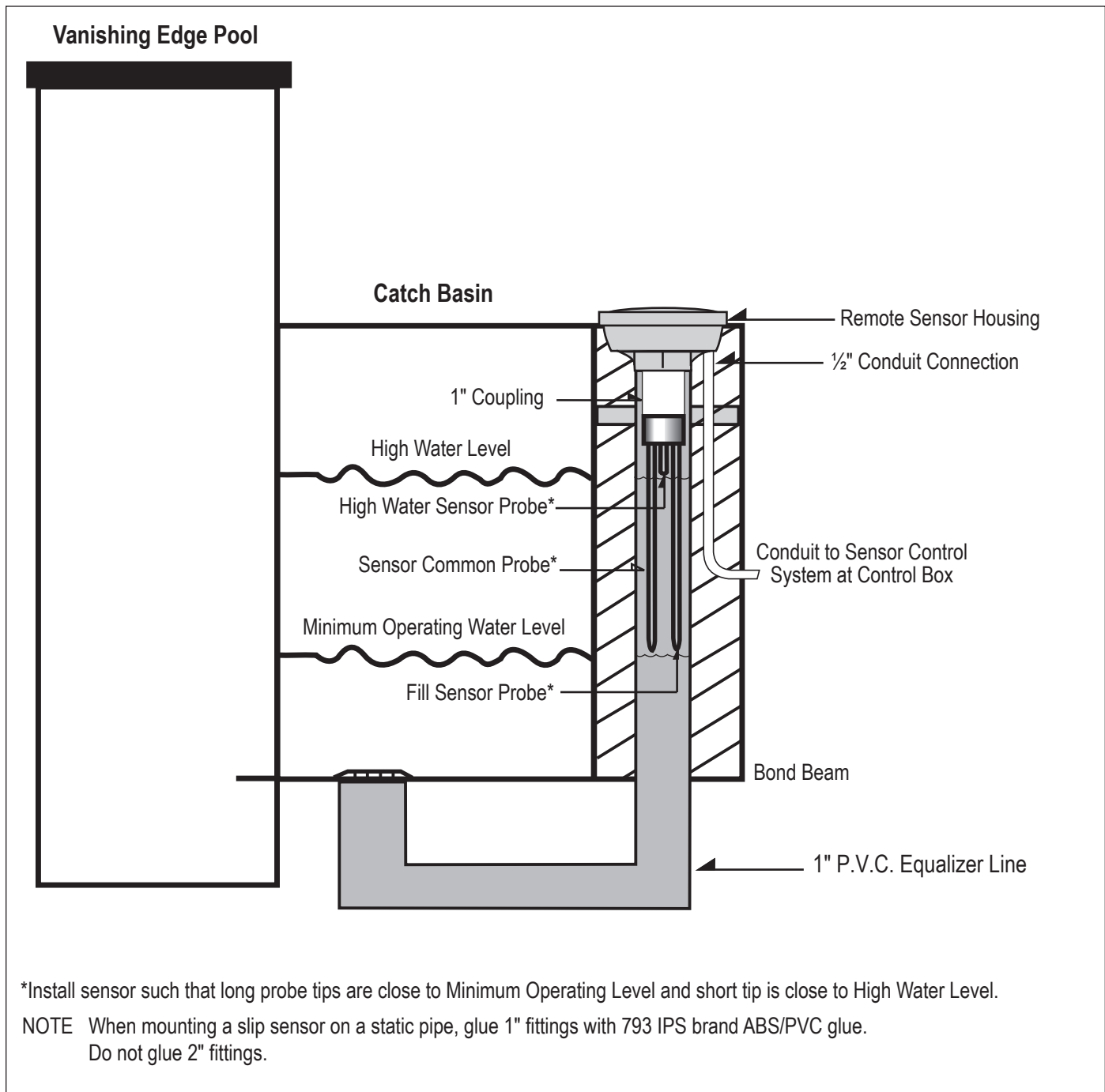

Figure 9. Installation of Vanishing Edge Pool

Section 4. Operation

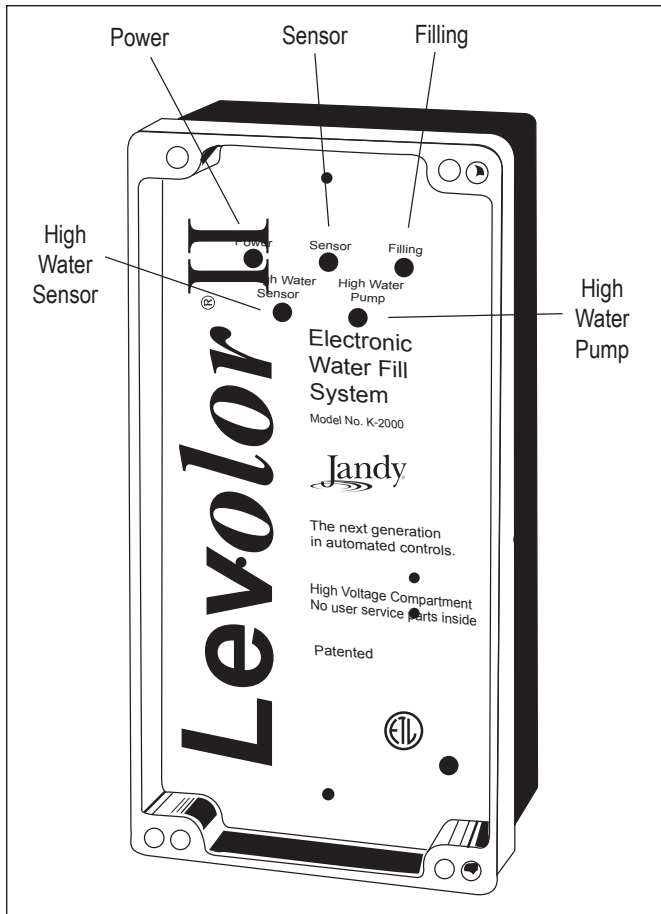

Figure 12. Controller Lights

4.1 Controller Lights

The controller has five (5) LED lights. See Figure 12 and Table 2, LED Indicators.

The Power light turns green when power is on.

The Sensor light turns yellow when the water is not touching the Fill Sensor.

The Fill light turns green when the valve is operational and filling, and it turns red when the unit enters Lockout Safety Mode.

The High Water Sensor light turns yellow when the High Water Sensor is in the water.

The High Water Pump light turns green when the vanishing edge pump is running.

Table 2. LED Indicators

LED	Function Indicated	Color	Operating Mode	Delay to Turn Function ON	Delay to Turn Function OFF
Power	Turn Power ON	Green	Power is ON	None	None
Sensor	Detect Low Water in Catch Basin	Yellow	Water is Low	None	None
Filling	Fill Pool	Green	Fill Valve is ON	20 Sec after Sensor Light Turns ON	20 Sec after Sensor Light Turns OFF
	Fill Safety Lockout	Red	Fill Valve is OFF	20, 40 or 60 Min	24 Hrs
High Water Sensor	Detect High Water in Catch Basin	Yellow	Water is High	None	None
High Water Pump	Pump Water from Catch Basin to Pool	Green	High Water Pump is ON	20 Sec, 1, 2½ or 5 Min	20 Sec or 2½ Min 5, 10, 15 or 20 Min 25, 30, 35 or 40 Min
	Stop Pumping Catch Basin Water to Pool	Off	High Water Pump is OFF	20 Sec or 2½ Min 5, 10, 15 or 20 Min 25, 30, 35 or 40 Min	Not Applicable

4.2 Fill Safety Lockout Mode

The Levolor is equipped with a Fill Safety Lockout Mode. This means that if the Fill Sensor probe has not been touched by water within the pre-set Fill time period, the controller turns the valve off for 24 hours and changes the Fill light from green to red.

The pre-set factory Fill time period is 20 minutes. See Table 2, LED Indicators, page 13.

To change the Fill time, follow the steps in *Section 4.5, Change Jumpers and Dip Switches*, and cut the appropriate jumper(s) as shown below in Table 3.

Table 3. Fill Safety Lockout Mode Settings

Jumper(s)	Fill Time Period
Factory Default	20 minute Fill before Lockout
Cut Either A or B	40 minute Fill before Lockout
Cut Both A and B	60 minute Fill before Lockout

NOTE Cutting the S-1 Jumper will disable the Safety Lockout function.

The jumpers are located at the top left of the circuit board. See Figure 13.

4.3 Pump On Delay Variable Timer

When water touches the High Water Sensor, there is a delay before the controller activates the High Water Pump.

The pre-set factory delay time is 2 ½ minutes. See Table 2, LED Indicators, page 13.

To change the delay time, follow the steps in *Section 4.5, Change Jumpers and Dip Switches*, and cut the appropriate jumper(s), as shown below in Table 4.

Table 4. Pump On Delay Settings

Jumper	Delay
Factory Default	2½ minutes
Jumper 1	20 seconds
Jumper 2	1 minute
Jumpers 1 and 2	5 minutes

The jumpers are located between the top left and middle controller lights on the circuit board. See Figure 13.

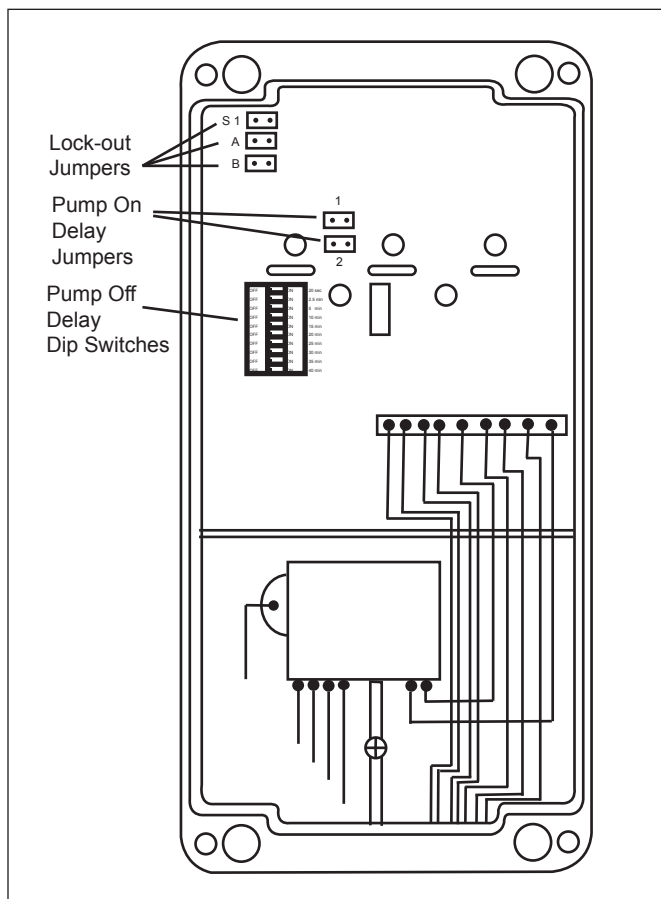

Figure 13. Jumpers and Dip Switches

4.4 Pump Off Delay Variable Timer









When the water is no longer touching the High Water Sensor, there is a delay before the controller deactivates the High Water Pump.

The pre-set factory delay time is 20 seconds. See Table 2, LED Indicators, and Figure 14.

To change the delay time, follow the steps in *Section 4.5, Change Jumpers and Dip Switches*, refer to Figure 14, and do the following:

1. Slide dip switch S1, which is set for 20 seconds, to the OFF position.
2. Slide one of the other nine (9) dip switches to the ON position, depending on the desired length of the delay.

NOTE Important! There can only be one (1) dip switch on at any time.

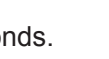
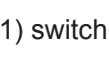
S1	OFF		ON	20 sec*
S2	OFF		ON	2.5 min
S3	OFF		ON	5 min
S4	OFF		ON	10 min
S5	OFF		ON	15 min
S6	OFF		ON	20 min
S7	OFF		ON	25 min
S8	OFF		ON	30 min
S9	OFF		ON	35 min
S10	OFF		ON	40 min

*Default is 20 seconds.

NOTE Only one (1) switch can be on at a time.

Figure 14. Pump OFF Delay Dip Switches

The dip switches are located below the top left controller light on the circuit board. See Figure 13.

4.5 Change Jumpers and Dip Switches

WARNING

Turn off the power to the control box before starting this procedure. Failure to comply may cause a shock hazard, resulting in severe personal injury or death.

To change the jumpers and dip switches, do the following:

1. Shut power off to the control box.
2. Remove the three (3) screws from the upper cover plate on the front of the control box.
3. Lift and remove the cover plate from the control box.
4. Locate the jumpers and dip switches. See Figures 13 and 14.
5. Make adjustments to the jumper(s) and/or dip switches, as necessary. See *Sections 4.2, Fill Safety Lockout Mode, 4.3, Pump On Delay Variable Timer, and 4.4, Pump Off Delay Variable Timer*.
6. Replace the top cover plate, being careful to align the LED lights with the plastic lenses in the plate.
7. Install the three (3) screws. **Do not overtighten** or you will damage the plastic mounts.
8. Turn on the power to the control box. The new timing changes will take effect.

NOTE If you adjust the jumpers or dip switches without turning the power off in advance, you will need to cycle the power from OFF to ON after making the adjustments for the new timing changes to take effect.

Section 5. Troubleshooting

Tools required: Multimeter that can read AC and DC voltage and No. 6 Phillips screwdriver.

5.1 Observations at Job Site

Make these initial observations when at the jobsite.

1. Proper wire usage between the controller and the valve. (Direct-burial style polypropylene-jacketed solid-core wire (at least 18-gauge wire): the same wire as the sensor wire.)
2. Proper wire nuts at the valve connection. (Grease-filled wire nuts or gel caps. Conventional wire nuts filled with silicone will not work since some silicones have acids that degrade copper wires.)
3. Sensor wire is continuous and not spliced. (No splices between the tips and the controller.)
4. Proper use of appropriate sensor and location: slip style for static pipes.
5. Proper power input voltage to the box and proper wiring for the voltage (110 or 220VAC).
6. Remove top face plate to verify that control lights on PCB line up with plastic lenses on the plate.

NOTE Before making changes to connections or settings, reset the controller by powering off for 10 seconds and then powering back on.

5.2 Test Operation of Control Unit

5.2.1 Prepare the Control Unit

1. Shut power off to the control box.

WARNING

Turn off the power to the control box before starting this procedure. Failure to comply may cause a shock hazard, resulting in severe personal injury or death.

CAUTION

Be sure to separate wires so that they are not touching each other or damage may result to the control box.

2. Disconnect the sensor from the sensor wires. Refer to Figure 7, Control Box Wiring, on page 10, and Table 1, Sensor Wire Connections, on page 11.
 - a. Disconnect the black wire for the Sensor Common probe from the yellow wire in the control box.
 - b. Disconnect the red wire for the Fill Sensor probe from the yellow wire with the blue stripe in the control box.
 - c. Disconnect the white wire for the High Water Sensor probe from the yellow wire with the red stripe in the control box.
3. Disconnect the valve and the relay from the control box. Refer to Figure 7, Control Box Wiring, on page 10, and Table 5, shown below.
 - a. Disconnect the valve from the blue wires in the control box.
 - b. Disconnect the relay from the red and gray wires in the control box.

Table 5. Valve and Relay Connections

Valve or Relay	Control Box Wires
Valve Wires	Blue
Relay Wires	Red and Gray

5.2.2 Simulate Fill Valve and Activate Pump

NOTE You have simulated a low water condition by following Step 2.b. in *Section 5.2.1*.

1. Twist the yellow wire and the yellow wire with the red stripe together to simulate a high water condition in the vanishing edge catch basin.
2. Remove the three (3) screws from the upper cover plate and lift the upper cover plate off the control box.
3. Verify that dip switches S2-S10 are set to the OFF position and that dip switch S1 is set to ON. See Figure 14, page 15.
4. Verify that jumpers 1 and 2 are installed on the control PCB. See Figure 13, page 14.
5. Replace the upper cover plate, making sure that the five (5) LEDs line up with the plastic lenses on the cover. Attach the upper cover plate to the control box using three (3) screws. **Do not over tighten.**
6. Restore power to the control box and observe the operation. The control box is working if steps 6 a - e and the steps in *Section 5.2.3* and *Section 5.2.4* occur.
 - a. The Power light turns green.
 - b. The Sensor light turns yellow.
 - c. The High Water Sensor light turns yellow.
 - d. After 20 seconds, the Fill light turns green and you can measure 24VAC across the blue wires with an AC volt meter.
 - e. After 2 ½ minutes, the High Water Pump light turns green and you can measure 24VDC across the red and gray wires with a DC volt meter.

5.2.3 Simulate Water Level Full

Shut off the fill valve by simulating a water level full condition.

1. Twist these three (3) wires together: yellow wire, yellow wire with blue stripe, and yellow wire with red stripe.
2. The Sensor light turns off immediately.
3. After 20 seconds, the Fill light turns off.
4. You can measure 0VAC across the blue wires with an AC volt meter.

5.2.4 Simulate Lowering of High Water Level in Catch Basin

Shut off the High Water Pump by simulating that the High Water level in the vanishing edge catch basin has lowered.

1. Disconnect the yellow wire with the red stripe from the yellow wire and yellow wire with the blue stripe.
2. The High Water Sensor light turns off immediately.
3. After 20 seconds, the High Water Pump light turns off.
4. You can measure 0VDC across the red and gray wires with a DC volt meter.

5.2.5 Manual Valve Override

There is a manual ON/OFF lever located just below the solenoid. If you are having a problem with the system and want to override the electronic water Levolor, you can manually open the valve by putting the lever in the up position ↑ (12 o'clock) for manual filling. See Figure 6, Manual Valve Lever, on page 9.

During normal operation, the lever must be in the horizontal position → (3 o'clock) for controller filling. See Figure 6, Manual Valve Lever, on page 9.

5.2.6 Troubleshooting Specific Conditions

Use the troubleshooting flow charts on the following pages to find and fix the following problems.

- Fill Will Not Turn Off
- Fill Will Not Turn On

5.3 Fill Valve Will Not Turn OFF

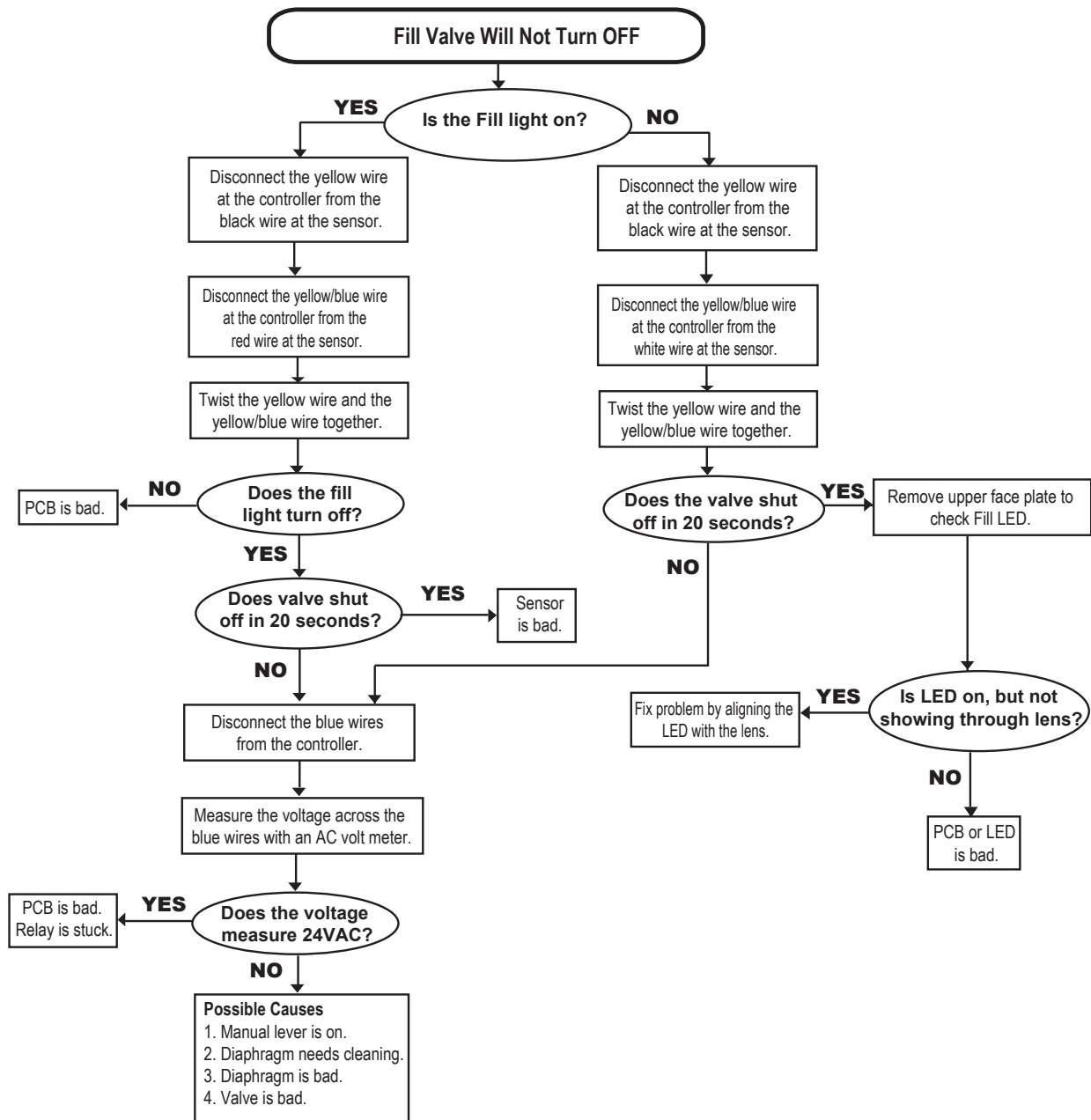

5.4 Fill Valve Will Not Turn ON

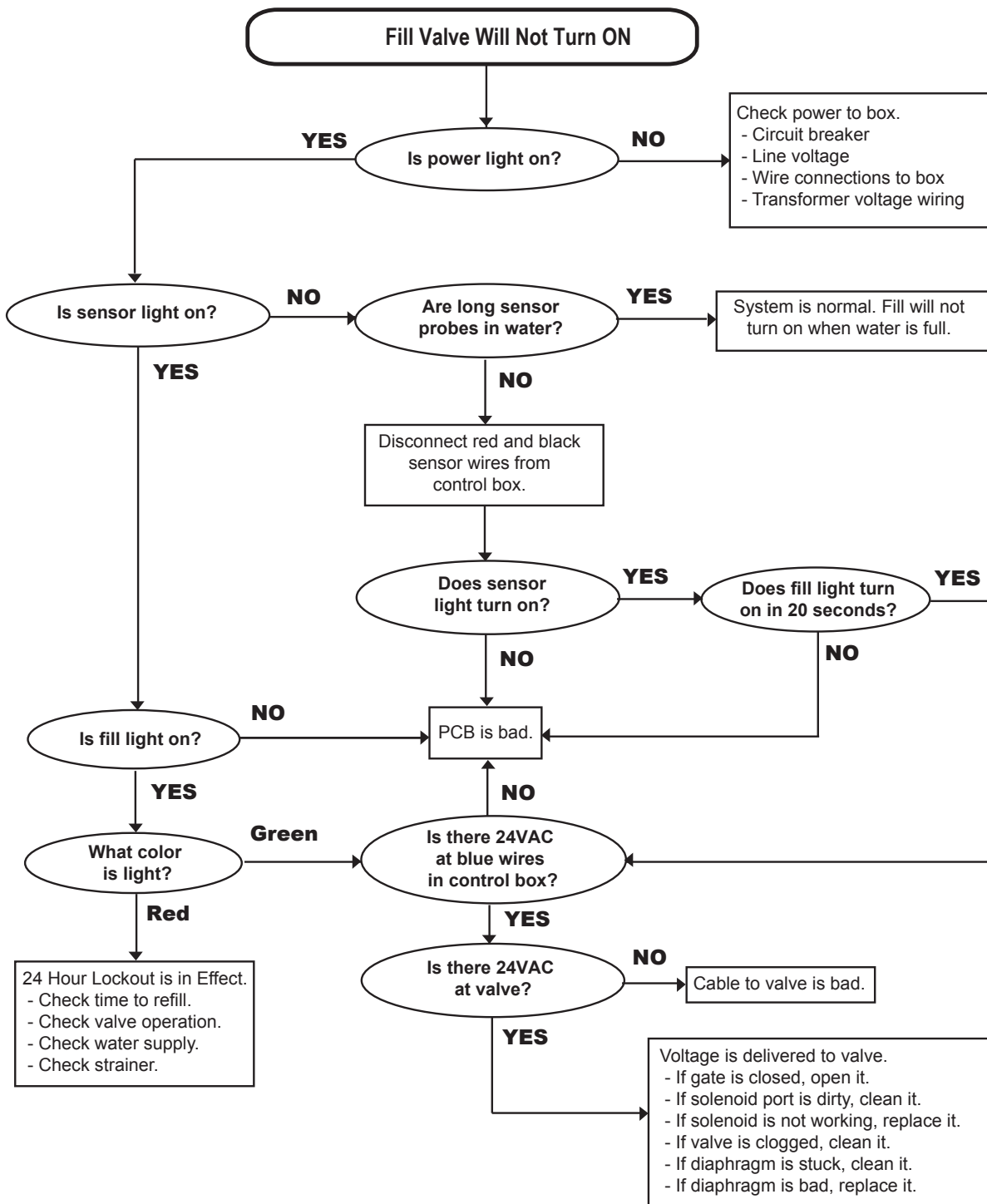

Zodiac Pool Systems, Inc.
2620 Commerce Way, Vista, CA 92081
1.800.822.7933 | www.ZodiacPoolSystems.com

©2016 Zodiac Pool Systems, Inc. ZODIAC® is a registered trademark of Zodiac International, S.A.S.U., used under license. All trademarks referenced herein are the property of their respective owners.

H0303700 Rev B



ETL LISTED
CONFORMS TO
UL STD 1563
CERTIFIED TO
CAN/CSA C22.2 NO. 218.1